



Computational study on the effects of exhaust gas recirculation on thermal and emission characteristics of HCCI diesel engine

M A Rather^{1*}, M M Wani¹

¹ Department of Mechanical Engineering, National Institute of Technology, Srinagar, J&K, 19006, India

ARTICLE INFO

Article history:

Received: 04 Jun 2018
Accepted: 20 Nov 2018
Published: 01 Dec 2018

Keywords:

HCCI,
NO_x,
EGR,
Combustion phasing,
Ignition delay,
Unburned hydrocarbons

ABSTRACT

In this paper, a computational in-cylinder analysis of HCCI diesel engine was carried out using IC Engine FORTE (ANSYS 18.2) software package. The analysis used pre-defined industry standard CHEMKIN format for specifying a chemical reaction mechanism during the combustion duration. The investigation was carried out for the effects of various EGR mass percentages on the thermal and emission characteristics of a diesel engine running on HCCI mode of combustion. It was observed that an increase in EGR concentration resulted in the decrease in peak in-cylinder pressure and temperature and it was also found that when the EGR rates were increased beyond 75% there was no combustion happening within the cylinder. A considerable decrease in the NO_x emissions was found with an increase in EGR mass percentage with almost negligible values when the EGR rates were increased beyond 50%, however there was a slight increase in un-burnt hydrocarbons.

* M A Rather

Email Address: Mushi.3afn_15@nitsri.net
10.22068/ijae.8.4.2833

1 Introduction

The environmental concerns and stringent legislation regulations regarding the exhaust gas emissions from the automotive and industrial sectors using IC engines as the prime sources of power has led the researchers to look for the development of new combustion concepts to comply with these considerations and reduce the emissions. The HCCI combustion mode is having the potential to meet the stringent emission standards (EURO VI) and CO₂ emission standards [1]. The homogenous charge compression ignition (HCCI) combustion is a controlled auto-ignition of homogenous fuel-air mixture during compression stroke and is characterized with lower NO_x and smoke emissions along with higher thermal efficiencies [2-4]. A lot of research work has been carried out numerically as well as experimentally analyzing various HCCI combustion mechanisms. However, there are several difficulties that need to be resolved before implementation of this mode of combustion, which include the excessive heat-release rate at high loads. The HCCI combustion is predominated by the chemical kinetic mechanisms as well as the thermal conditions that the mixture goes through during the compression process [5-6]. The HCCI combustion leads to nearly instantaneous heat release resulting in rapid pressure rise rate particularly at high loads. Researchers have found that this instantaneous pressure-rise rate can be mitigated by combustion-phasing retard [7] which can reduce the maximum pressure-rise rate and prolong the combustion duration.

Various combustion-phasing control techniques have been studied which include variable compression ratio, Variable valve timing, exhaust gas recirculation and intake air heating [8-10]. The main objective of these techniques is to adjust the temperature of the compressed gases so that the air-fuel mixture auto-ignites at a desired crank angle. EGR technique is preferred to control the ignition timing and the burn rate in HCCI combustion [11]. The EGR technique has a several effects on thermal and emission characteristics of HCCI combustion. EGR influences the compression ignition combustion in three ways. The first one is thermal effect; the presence of CO₂ and H₂O in exhaust gas increases the specific heat capacity of the

charge leading to reduced maximum combustion temperature which affects the NO_x formation and the recirculation of exhaust gas increases the inlet charge temperature which is responsible for a decrease in volumetric efficiency. Secondly the chemical effect in which the combustion products in the EGR will take part in dissociation of species during combustion reactions. Thirdly, the dilution effect which leads to a decreased availability of O₂ for combustion process. Based on the studies, it has been demonstrated that cooled EGR is beneficial for controlling the auto-ignition in HCCI combustion [12-15].

In the present work the effect of different EGR mass percentage rates on the thermal and emission characteristics of a single cylinder four stroke diesel engine running on HCCI mode of operation were determined numerically using an academic software package.

The introduction presents the purpose of the study and its relationship to earlier work in the field.

It should not be an extensive review of the literature. It is usually less than one formatted page.

Please make sure that the total number of the pages of your manuscript is an even number. This will assist in organizing the final structure of the published volume of the journal.

Please check the integrity of the manuscript in a Portable Document Format (PDF) before submission. The journal office may reject your submission if it comes up with problems in its PDF format.

2 The simulation model

The simulation for the combustion process was carried out using IC ENGINE (FORTE) module of ANSYS 18.2 software package which utilizes highly efficient coupling of detailed pre-defined industry standard chemical kinetics CHEMKIN, liquid fuel spray and turbulent gas dynamics. Direct injection HCCI Diesel engine geometry is transformed into 60° sector using periodic boundary conditions at the front and back face of the sector as shown in Figure 1 is used in order to reduce mesh size and solution time. A numerical grid shown in Figure 2 containing 218364 cells was adopted to model the combustion chamber sector geometry after accomplishing the grid-independent results.

The various engine geometry parameters are given in Table 1.

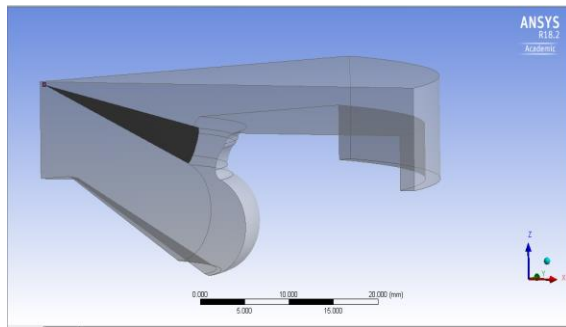

Figure 1. A 60° sector model geometry with spray cone using ANSYS Designmodeller

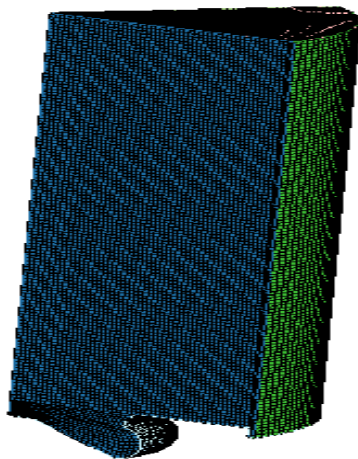

Figure 2. A computational grid for the sector geometry using ANSYS Mesh

Table 1. Engine Geometry Parameters

No. of cylinders	Bore × Stroke	Connecting rod length	Compression ratio	Engine speed	Squish
1	89.9 mm × 110 mm	165 mm	15.5	1500 rpm	4.56 mm

The computations were carried out for the crank angle range from 180 degree BTDC (540 degree CA) to 113 degree ATDC (833 degree CA). A full Reynolds-averaged Navier-Stokes equations with the RNG (Re-Normalization Group) $k-\epsilon$ model is used to describe the flow field. The simulation was carried by imposing the boundary conditions and initial conditions as shown in Table 2. The modeling of combustion process was carried out for different EGR mass percentages and the effect on thermodynamic parameters and emissions was obtained.

Table 2. Initial and Boundary Conditions

Inlet air pressure	Inlet air temperature	Cylinder wall temperature	Piston top temperature	Cylinder Head Temperature	Fuel injection temperature
3.45 bar	404K	390K	510K	460K	410K

3 Model validation

The simulation results for the HCCI diesel engine with no EGR were compared and validated with the experimental data from the engine with similar geometrical and operational specifications and imposing the same initial and boundary conditions. The comparison of the experimental and simulation results of the baseline case is shown in Figure 3.

The input parameters such as Boundary conditions, Spray modeling parameters, Turbulence modeling parameters, material and grid select of the cylinder and engine have been given to converge.

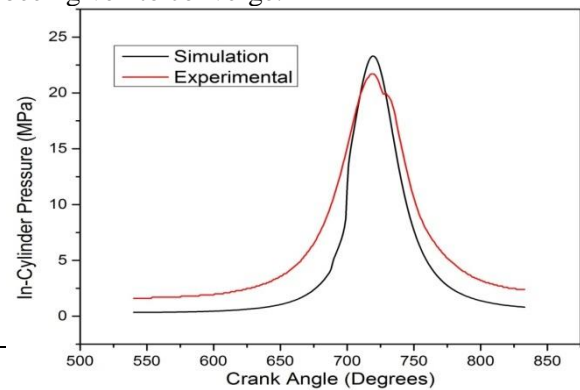

Figure 3. Validation of in-cylinder pressure with crank angle of experimental data and simulation data of baseline case

4 Results and Discussion

The effects of EGR on the in-cylinder pressure, temperature and apparent heat release rate with varying percentage of EGR were analyzed. The results indicate that the expected trends are maintained throughout the combustion duration irrespective of the EGR concentrations. However, it can be seen that the maximum in-cylinder pressure and temperature decrease with an increase in EGR concentration, owing to an increase in the overall heat capacity and dilution effect of the charge within the cylinder.

The variation of in-cylinder pressure due to increase in EGR concentrations is shown in Figure 4. It is observed that the in-cylinder pressure has a decreasing trend with an increase in EGR mass percentage and is reduced to the motoring pressure when the EGR rate is increased beyond 75%. The induction of EGR increases the residuals within the combustion chamber. The presence of these internal residuals due to EGR results in an increase in the burn duration by 34% and as much as 15% broadening of the temperature distribution [16]. An increased concentration of EGR increases the concentration of tri-atomic molecules such as CO₂ and H₂O which is responsible for increasing in the overall specific heat capacity of the gaseous charge within the cylinder. This increased heat capacity reduces the in-cylinder temperature and enhances the ignition delay. The effect of EGR concentration on the in-cylinder temperature is shown in Figure 5.

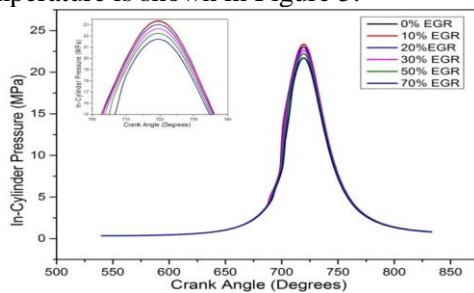

Figure 4. Variation of in-cylinder pressure with crank angle for various EGR percentages

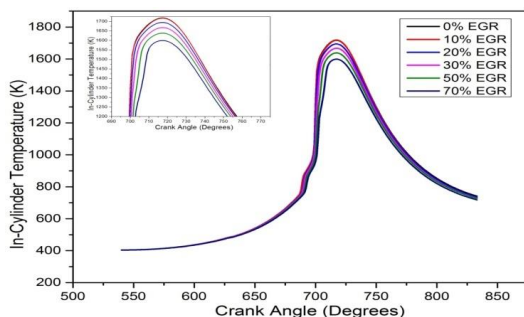

Figure 5. Variation of in-cylinder temperature with crank angle for various EGR percentages

The apparent heat release rate with varying crank angle for different EGR percentages is shown in Figure 6. The result shows the delayed apparent heat release rate with an increase in EGR concentration. The start of the combustion delay and the peak value of heat release rate also decrease with an increase in EGR concentration. The increased EGR along

with the instantaneous expansion of cylinder volume partially counteracts the physical chain reaction of burned gases compressing unburned gases which retards the combustion phasing resulting in decreased the heat release rates [17]. The increase of EGR concentration beyond 30% results in the delayed heat release time. This increased ignition delay and lack of oxygen deteriorates the combustion leading to a sudden increase in the specific fuel consumption.

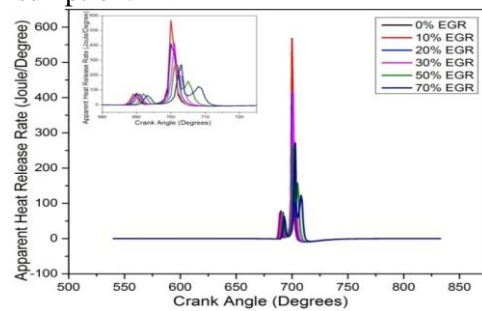

Figure 6. Variation of apparent heat release rate with crank angle for various EGR percentages.

The high EGR rate supplied to the engine at the expense of the suction air prevents combustion to occur due to the lack of sufficient oxygen. HCCI engines produce high levels of CO and unburned hydrocarbons which is controlled by the gas temperature and chemical reactions occurring during the combustion duration. These are mainly formed in the regions wherein the gas temperatures are lower. Figure 7 and Figure 8 show the variation of CO and unburned hydrocarbon formation with varying crank angle for different EGR mass percentages. The increased concentration of EGR is the primary cause of increased unburned hydrocarbon. EGR causes the reduction in in-cylinder temperature and increases the delay period and works as retarding ignition timing.

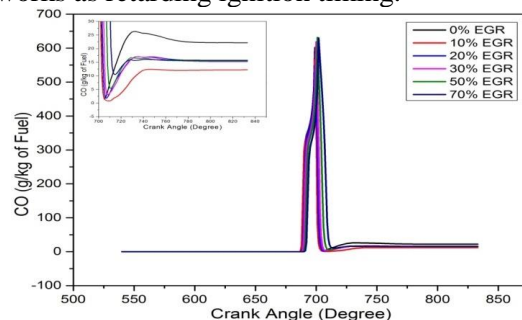

Figure 7. Variation of CO formation with crank angle for various EGR percentages

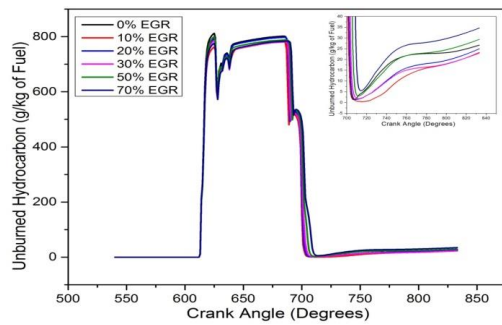

Figure 8. Variation of unburned hydrocarbon with crank angle for various EGR percentages

The induction of EGR into the pre-combustion mixture reduces the oxygen concentration and reduces the in-cylinder temperature thereby reducing the tendency of the formation of NO_x emissions. It is observed from Figures 9, 10 and 11 that the NO_x content during the combustion duration gets decreased with an increase in EGR concentration. The NO_x concentrations were reduced to nearly zero as the EGR concentration was increased beyond 50%. In HCCI diesel engine the homogenous mixture gives the EGR greater opportunity to affect the combustion process. EGR is a recommended technology to mitigate the NO_x formation at the expense of unburned hydrocarbon emissions, particularly at higher loads [18].

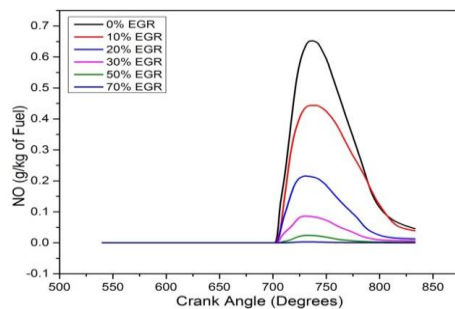

Figure 9. Variation of NO formation with crank angle for various EGR percentages

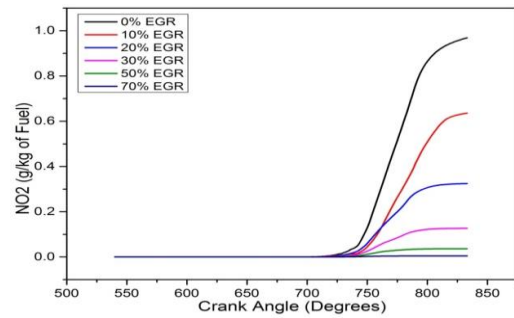

Figure 10. Variation of NO₂ formation with crank angle for various EGR percentages

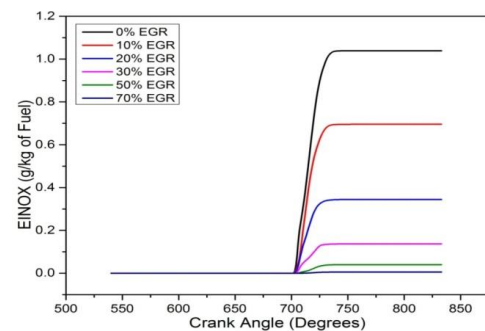

Figure 11. Variation of EINOX with crank angle for various EGR percentages

5 Conclusions

The effects of EGR mass percentage on the thermal and emission characteristics of a single cylinder diesel engine running on HCCI combustion mode were analyzed and the following conclusions were obtained.

The pressure and temperature within the cylinder were reduced with an increase in the amount of EGR. However, the IMEP was increased leading to an increase in thermal efficiency.

There is a considerable reduction in the NO_x formation and is almost reduced to zero when the EGR percentage is increased beyond 50%. There is a moderate effect of EGR percentage on CO and unburned hydrocarbon emission. The formation of these emissions increases with an increase in amount of EGR.

Declaration of Conflicting Interests

The author(s) declared no potential conflicts of interest with respect to the research, authorship, and/or publication of this article.

References

- [1] B. Harisankar, S. Murugan, Homogenous

- Charge Compression Ignition (HCCI): Mixture preparation and control strategies in diesel engines, *Renewable and Sustainable Energy Reviews* 38 (2014) 732-746.
- [2] C. Zhang, Han Wu. Combustion Characteristics and performance of a methanol fuelled homogenous charge compression ignition (HCCI) engine. *Journal of Energy Institute* 89 (2016) 346-353.
- [3] S. Natarajan, M. Akshay Kumar, A. U. Meenakshi Sundereswaran. Computational analysis of an Early Directed HCCI engine using Bio ethanol and Diesel Blends as Fuel. *Energy Procedia* 105 (2017) 350-357.
- [4] Fuquan, Z. Thomas, W.A. Dennis, N. A. John, E.D. James, A. E. Paul, M.N. Homogenous Charge Compression Ignition (HCCI) Engines, Key Research and Development Issues, SAE, Warrendale, PA 15096-0001-USA, 2003.
- [5] Yusuke Nakamura, Dong-Won Jung, and Norimasa Iida. Closed-Loop Combustion Control of HCCI Engine with Re-Breathing EGR System, SAE International 2013-32-9069.
- [6] Xiao Fu, Suresh K. Aggarwal. Two-stage ignition and NTC phenomenon in diesel engines, *Fuel* 144 (2015) 188-196.
- [7] M. Sjöberg, Dec, J.E. Babajimopoulos, A. Assanis, D. Comparing Enhanced Natural Thermal Stratification Against Retarded Combustion Phasing for Smoothing of HCCI Heat-Release Rates. SAE Technical Paper 2004-01-2994, 2004.
- [8] Haraldsson, G. Tunestal, P. Johansson, B. Hyvonen J, HCCI Combustion Phasing In a Multi-Cylinder Engine Using Variable Compression Ratio, SAE Technical Paper 2002-01-2858, 2002.
- [9] Agrell, F. Angstrom, H.E. Erikson, B. Wikander, J. Linderyd. Integrated simulation and Engine Test of Closed Loop HCCI control by aid of Variable Valve Timings. SAE Technical Paper 2003-01-0748, 2003.
- [10] Sjöberg M, Dec J.E. Combined effects of fuel type and Engine speed on intake air temperature requirements and completeness of bulk gas Reactions in an HCCI Engine. SAE Technical Paper 2003-01-3173, 2003.
- [11] Xing-Cai Lu, Wei Chen, Zhen Huang. A fundamental study on the control of the HCCI combustion and emissions by fuel design concept with controllable EGR. Part 2. Effect of operating conditions and EGR on HCCI combustion. *Fuel* 84 (2005) 1084-1092.
- [12] P. Kashyap Chowdary, P. Rao Ganji, M. Senthil Kumar, C. Ramesh Kumar, S. Srinivasa Rao. Numerical analysis of C.I engine to control emissions using exhaust gas recirculation and advanced start of injection. *Alexandria Engineering Journal*, 55 (2016) 1881-1891.
- [13] M. T. Chaichan and A. M. Saleh, Practical investigation of the effect of EGR on DI multicylinders diesel engine emissions, Al Anbar UniversityJ, 2012
- [14] S. Jafarmadar, P Nemat, R Khodaie. Multidimensional modeling of the effect of Exhaust Gas Recirculation (EGR) on exergy in terms in an HCCI engine Fuelled with a mixture of natural gas and diesel. *Energy Conversion and Management* 105 (2015) 498-508
- [15] S. Gowthaman, A. P. Sathiyagnanam. Analysis of the optimum inlet air temperature for controlling homogenous charge compression ignition (HCCI) engine. *Alexandria Engineering Journal*, 2017.
- [16] B. Lawler, S. Mamalis, S. Joshi, J. Lacey, O. Guralp, P. Najt, Z. Filipi. Understanding the effect of operating conditions on thermal stratification and heat release in a homogeneous charge compression ignition engine. *Applied Thermal Engineering* 112 (2017) 392-402.
- [17] H. Huang, C. Zhou, Q. Liu, Q. Wang, X. Wang. An experimental study on the combustion and emission characteristics of a diesel engine under low temperature combustion of diesel/gasoline/n-butanol blends. *Applied Energy* 170 (2016) 219-231.
- [18] [18] J. Thangaraja, C. Kannan. Effect of exhaust gas recirculation on advanced diesel combustion and alternate fuels-A review. *Applied Energy*.18 (2016) 169-184
- [19]