

Iran University of
Science and Technology

Optimum Pareto design of vehicle vibration model excited by non-stationary random road using multi-objective differential evolution algorithm with dynamically adaptable mutation factor

M. Salehpour*, A. Jamali, A. Bagheri, N. Nariman-zadeh

¹ Faculty of Mechanical Engineering, University of Guilan, Rasht, Iran

ARTICLE INFO

Article history:

Received : 07 Aug 2018

Accepted: 05 Sep 2018

Published: 01 Dec 2018

Keywords:

Five degree of freedom
vehicle vibration model
Non-stationary random road
Pareto, Multi-objective
optimization
Differential evolution
Fuzzified mutation

ABSTRACT

In this paper, a new version of multi-objective differential evolution with dynamically adaptable mutation factor is used for Pareto optimization of a 5-degree of freedom vehicle vibration model excited by non-stationary random road profile. In this way, non-dominated sorting algorithm and crowding distance criterion have been combined to differential evolution with fuzzified mutation in order to achieve multi-objective meta-heuristic algorithm. To dynamically tune the mutation factor, two parameters, named, number of generation and population diversity are considered as inputs and, one parameter, named, the mutation factor as output of the fuzzy logic inference system. Conflicting objective functions that have been observed to be optimally designed simultaneously are, namely, vertical seat acceleration, vertical forward tire velocity, vertical rear tire velocity, relative displacement between sprung mass and forward tire and relative displacement between sprung mass and rear tire. Furthermore, different pairs of these objective functions have also been chosen for bi-objective optimization processes. The comparison of the obtained results with those in the literature unveils the superiority of the results of this work. It is displayed that the results of 5-objective optimization subsume those of bi-objective optimization and, consequently, this achievement can offer more optimal choices to designers.

1 Introduction

One of the most important part of a typical vehicle which considerably influences on the ride comfort of passengers and road holding capability of the vehicle is suspension system [1-2]. As a matter of fact, achieving an acceptable trade-off between road holding capability and ride comfort is always a challenging task for the researchers because the two aforesaid criteria conflict each other. Therefore, designing a suspension system means to seek a proper balance between these two contradictory criteria [3]. Furthermore, a proper suspension system should achieve sufficient road holding ability with having good ride comfort [4]. Totally, three types of suspension systems are used in vehicle to suppress the unwanted effects

of road irregularities which are named, passive, semi-active and active ones. Passive ones, often used in traditional vehicles, consist of springs and dampers located between the vehicle body (sprung mass) and wheel-axle assembly (unsprung mass). Passive suspensions can only provide good ride comfort or good road holding but semi-active ones with their changeable damping characteristics and low power expenditure suspension systems reach a promising amelioration [2]. Active suspension uses an external energy source [1] for an actuator which is situated between the sprung and unsprung mass parallel to the suspension components. Active suspensions provide auspicious functioning for the suppression of the undesirable vibrations

* M. Salehpour

produced by the road excitation in comparison with the passive and semi-active suspension [2]. Baumal et al. [5] presented a global technique search based on genetic algorithm (GA) for the optimization of an active vehicle suspension minimizing a performance criteria while satisfying a number of other design specifications. It has been shown that road irregularities has little influence on the seat acceleration of active suspension when compared to passive one. It has also been resulted that realistic execution of the active skyhook dampers must be characterized by attaining actuators that can give the requisite power. In order to collate results with a local optimization search technique, the gradient projection method and GA were used for the optimization of the passive suspension system. Comparison of GA results and the ones of gradient projection method showed the superiority of GA method. It has been proved that although GA needs more computing effort than a gradient projection method and it does not need any gradient of the objective function and constraints regarding the set of design variables. It was also presented that the efficacy of the GA can be enhanced by checking formerly analyzed designs so as to prevent re-assessing the fitness for a same design. For ameliorating efficiency and uniformity of results, the GA parameter values, such as population size and mutation probability, might be adjusted more efficaciously.

Marzbanrad et al. [6] proposed an optimal preview control of a vehicle suspension system traversing on a rough road. A three-dimensional seven degree-of-freedom car-riding model and some information of some types of road surface roughness, containing haversine (hole/bump) and stochastic filtered white noise models, were utilized in this study. It was supposed that contactless sensors fastened the vehicle front bumper evaluate the road surface height at some distances in the front of the car. The suspension systems were optimized with regard to ride comfort and road holding capability considering accelerations of the sprung mass, tire deflection, suspension rattle space and control force. The functioning and power requisite of active, active and delay, active and preview systems were calculated and compared with those for the passive system. The results confirmed that the optimal preview control enhances all features of the vehicle suspension operation while needing less power.

Chen et al. [7] presented an adaptive sliding controller for a non-autonomous quarter-car suspension system with time-varying loadings. The system model was firstly represented with regard to the static positions subject to the

nominal car-body load. In order to deal with the system nonlinearities and uncertainties, the function approximation method was utilized. After that the control rule and the update laws were planned to ensure the stability of the closed-loop by using Lyapunov direct method. Albeit the system encompasses time-varying uncertainties, the proposed controller offered considerable performance amelioration in comparison with the passive design in terms of ride comfort. Additionally, the controller can be recognized with only two characteristics, namely, position and velocity feedback of the car body. Though this showed a significant simplification in hardware execution.

Gao et al. [8] proposed an approach based upon a load-dependent controller for the multi-objective control of active suspension quarter-car model considering uncertain parameters by using linear matrix inequalities. The gain matrix of the obtained controllers pivoted on the online accessible data of the body mass which changes with vehicle load based on parameter-dependent Lyapunov functions. Comparison of the method of this work with the previous approaches showed the good performance of the results of this work.

Du and Zhang [9] presented a delay-dependent H_∞ controller design approach for active vehicle suspensions with actuator time delay. Three main criteria, namely, ride comfort, road holding, and suspension deflection were observed by modelling an appropriate state feedback H_∞ controller to achieve a compromise between the aforesaid criteria. By extracting the upper bound for the scalar product of two vectors, the state feedback H_∞ control law was achieved based upon the outcome of delay-dependent matrix inequalities. It has been shown that modelling a controller that observes the time delay effect in advance can insure the closed-loop be asymptotically stable within permissible time delay bound. A simulation example was utilized to show that the designed controller can efficaciously attain the optimal vehicle suspension functioning even with actuator time delay to a certain level.

N. Nariman-Zadeh et al. [10] proposed a multi-objective uniform-diversity genetic algorithm (MUGA) with a diversity preserving mechanism called the ε -elimination algorithm for multi-objective optimization of a five-degree of freedom vehicle vibration passive suspension model. Conflicting objective functions that have been observed for optimization were, namely, vertical seat acceleration, vertical forward tire velocity, vertical rear tire velocity, relative displacement between sprung mass and forward tire and relative displacement between sprung mass and rear tire.

Various pair-wise 2- and 5-objective optimization processes were performed. In addition, it has been shown that the results of 5-objective optimization subsume those of 2-objective optimization using Pareto frontiers and offer, as a result, more options for optimal design. Significantly, it was demonstrated that a trade-off optimum design point can be obtained from those Pareto fronts. Comparison of the results of this work with those in the literature confirmed the superiority of the results of this study.

Guo and Zhang [11] worked on the active suspension control for non-stationary road surface applying robust H_∞ control and linear matrix inequality optimization. The H_∞ state feedback control strategy with time-domain hard constraints was introduced to design the active suspension control system of a two-degree-of-freedom quarter car model considering parameter uncertainty. It has been shown that the suggested control approach can attain a considerable amelioration on ride comfort and fulfil the specifications of dynamic suspension deflection, dynamic tire loads and required control forces considering given constraints.

Jamali et al. [1] presented a multi-objective uniform-diversity genetic algorithm (MUGA) combined with Monte Carlo simulation (MCS) to find Pareto frontiers of some incommensurable objective functions in the optimum design of an uncertain five-degree of freedom vehicle active suspension model. The ten contradictory objective functions that have been observed for minimization are, namely, mean and variance of vertical acceleration of seat, means and variances of vertical velocity of both forward and rear tires, means and variances of relative displacements between sprung mass and both forward and rear tires. Hence, an optimum robust design was obtained based on Pareto approach considering the probabilistic metrics of those objective functions by the combination of MCS and MUGA. A trade-off design point was chosen as a compromise from the view of the whole Pareto fronts obtained from the combination of MCS and MUGA approach. The robustness of the proposed design in comparison with the deterministic one proved the superiority of the proposed approach of this work.

Mahmoodabadi et al. [12] suggested a new approach based on the combination of genetic algorithm operators and particle swarm optimization algorithm. Tuning of the operators such as traditional and multiple-crossover was based on fuzzy logic. To analyze the behavior of the presented algorithm, it was carried out on nine and five popular single and multi-objective test

functions, respectively. The results were compared with the ones of some other approaches in both single and multi-objective classes. The results proved that the proposed hybrid algorithm is a successful method in the both single and multi-objective optimization area. Furthermore, this hybrid algorithm has been successfully used to optimally model the vehicle passive suspension system as used in [10]. The conflicting objective functions were chosen as [10]. Comparison of the results with those of [10] confirmed the very good performance of the proposed method of this work. It is important to notice that the design variables used in [1, 10, 12] are, namely, seat damping coefficient, vehicle suspension damping coefficient, seat stiffness coefficient, vehicle suspension stiffness coefficient and seat position in relation to the center of mass. In addition in [1], the damping coefficients for the active suspension are used as design variable besides the aforesaid design variables. In all three aforementioned references, a double bump used as the road excitation. In [1], four uncertain parameters, namely, seat mass, sprung mass, excitation amplitude, and excitation frequency, are also used besides the certain parameters.

It should be noted that there is a good capacity to utilize global optimization approaches for suspension system design [5]. Therefore, by observing this point and reviewing the above-mentioned points, multi-objective optimization of vehicle vibration model [10, 12] with road irregularities based on the non-stationary road surface [11] has been conducted in this work.

The optimization methods based on the evolutionary algorithms (EAs) are different from the gradient based methods. Main different is that in the gradient based methods, the starting point and the direction of gradient has a great influence on the final result. In fact, if the starting point is a proper point, there is a good chance to reach the global optimum. Otherwise, the algorithm may be trapped in the local optima [13]. But, in case of EAs, because of the stochastic population-based nature of them, the algorithm does not depend on the starting point and the direction of the gradient of the objective function. As a matter of fact, their performance depends on the randomness which provides the diversity of the population. The aforementioned randomness may also help the perturbation of the search point which can help to escape from the local optima. On the other hand, the population based nature of the EAs can help them to change the search direction in which to reach the local optima and at the same time in some point to not improve the objective function in order to evade from the local optima and

converge toward global optimum [14]. The intrinsic parallelism in EAs helps them to be appropriately qualified for using in multi-objective optimization problems (MOPs). In multi-objective optimization problems, there are some objective functions which have to be optimized (minimized or maximized) simultaneously. These objectives are often in contrast with each other, therefore when one of them ameliorates, the other one worsens. Consequently, there is no unique answer which shows most optimal performance from the view of all the objective functions [10]. In fact, in the multi-objective optimization problem, there is a group of optimum answers which are non-dominated to each other but dominated to the remainder of the answers in the feasible space. These non-dominated optimum solutions are called Pareto-optimal set [15]. This point considerably differentiates the intrinsic nature between single and multi-objective optimization problems [10]. It is important to notice that the aforesaid non-dominated optimum solutions sort in various levels based on the Pareto fronts. In fact, first front or Pareto curve with first rank contains the most important solutions.

There are two main goals in searching process of EAs [16]:

1. Guiding the search process towards to the correct Pareto front
2. Avoiding premature convergence or conserving population diversity

In this work, differential evolution (DE) [17-18], which is one of the recently proposed methods of EAs, is used to optimally design the five degree of freedom vehicle vibration passive model [10, 12]. DE is a swift and robust algorithm [19-20] and can surpass well-known EAs in most of the numerical benchmark problems [20]. In fact, performance of DE is mostly influenced by two important parameters which are namely, mutation and crossover [21-23].

As seen in the literature, high value of mutation factor can be efficacious in global search. But, low value of that can accelerate the convergence rate. Furthermore, the larger value of crossover probability may produce the higher value of diversity of the population, but, a lower one of that may lead to local exploitation [23]. Therefore, it could be easily perceived that choosing an appropriate value of one of those aforesaid parameters may have a considerable effect on the output of the algorithm. Consequently, it is very evident that tuning the values of the aforementioned factors may improve the performance of DE. In this paper, fuzzy logic [24] is applied to dynamically adapt mutation factor of

DE. Some works of the hybrid usage of DE and fuzzy method is addressed here as follows:

Patricia Ochoa et al. [25] presented an approach based on the hybrid usage of fuzzy logic and DE for dynamically adapting the mutation parameter. It has been depicted that the optimum results of the differential evolution algorithm with Fuzzy F (mutation factor) Decrease is superior to the ones of the differential evolution algorithm with F increase.

Salehpour et al. [26] proposed an approach based on the combination of DE and fuzzy inference system to dynamically tune the mutation factor. In order to achieve this goal, two parameters, named, the number of generation and population diversity have been chosen as inputs and, one parameter, named, the mutation factor as output of the fuzzy logic inference system. Comparison of the obtained results with classical DE and [25] confirmed the superiority of the approach of this work. Then, this method is used to optimally design the five degree of freedom vehicle vibration model [10, 12] in single objective optimization area. The optimum result proposed by this work showed a very good behavior comparing with the ones of [10, 12].

In this paper, a multi-objective differential evolution with dynamically adaptive mutation factor [26] is used for multi-objective optimization of a 5-degree of freedom vehicle vibration passive model [10, 12] excited by non-stationary random road surface [11]. The conflicting objective functions that have been selected for optimization and the design variables used here are chosen the same as [10, 12]. Multi-objective optimization has been done in 2- and 5-objective areas. Comparison of the obtained results with those in the literature shows the superiority of the results of this work.

2 Multi-objective Fuzzified Differential Evolution (MFDE)

Generally, multi-objective optimization problem is to seek a design variables (decision variables) vector (X^*) for fulfilling problem constraints to achieve most proper answers for objective functions ($F(X)$) [10, 16]:

$$X^* = \{x_1^*, x_2^*, \dots, x_n^*\}^T \quad (1)$$

$$F(X) = \{f_1(X), f_2(X), \dots, f_k(X)\} \quad (2)$$

in which $X^* \in R^n$ and $F(X) \in R^k$. The optimization problem is subject to m inequality constraints:

$$g_i(X) \leq 0 \quad i = 1, 2, \dots, m \quad (3)$$

and p equality constraints:

$$h_j(X) = 0 \quad j = 1, 2, \dots, p \quad (4)$$

In fact, objective functions must be optimized (either minimized or maximized) simultaneously.

But, all of the maximization problems can be converted to minimization ones by producing equation (2) by -1 [27]. Therefore, it is possible to assume the optimization process as the minimization one. As a matter of fact, the aforementioned multi-objective minimization problem based on the Pareto approach needs some definition such as Pareto dominance, Pareto optimality, Pareto set and Pareto front which the respectful reader may refer to [10, 16] for achieving more details.

At first, in DE, in each generation, two operators, namely, mutation and crossover, are applied to parents population, respectively, to produce offsprings population.

$$x_i^G = (x_{1,i}^G, x_{2,i}^G, \dots, x_{d,i}^G), \quad i = 1, 2, \dots, n \quad (5)$$

$$v_i^G = x_{best}^G + F \cdot (x_{r_1}^G - x_{r_2}^G), \quad r_1 \neq r_2 \neq i \quad (6)$$

Where, n , G , d , $F \in [0, 1]$ [26], $x_{r_1}^G$ with $x_{r_2}^G$ and x_{best}^G are, namely, number of population, number of generation, number of dimension of the search space, mutation factor, two randomly chosen different vectors and the vector which is randomly chosen from the first front of the previous generation so far [28], respectively.

$$u_{j,i}^G = \begin{cases} v_{j,i}^G & \text{if } r_i \leq C_r \text{ or } j = J_r, \\ x_{j,i}^G & \text{Otherwise.} \end{cases} \quad j = 1, 2, \dots, d \quad (7)$$

In which, r_i is a number randomly selected from $[0, 1]$; J_r is used in equation (7) to guarantee that $u_i^G \neq x_i^G$ and $C_r \in [0, 1]$ [26] indicates crossover rate (crossover probability).

It is important to notice that for starting the algorithm, an initial population is randomly generated, and used as the parents population at first. But, in next generations the above-mentioned mechanism is reiterated.

The parents and offsprings population are combined together using non-dominated sorting algorithm [29] and crowding distance criterion [29] and the resulted population enters the next generation. The aforesaid procedure is repeated until achieving the final optimum solutions based on the Pareto frontiers.

The logic of non-dominated sorting algorithm is that in this algorithm each individual of the population is compared with all of the other members of the population. In this process, if the assumed individual is supreme to the others (dominates others) or non-dominated in relation to them, it will remain in the population. Then, the non-dominated sorting algorithm assigns this individual a position in the first front. This mechanism is repeated for all the others of the population to construct the first front. After creating first front, the members of the first front are deleted from the population and the procedure is reiterated for the remainder of the population.

By completing this mechanism, all of the Pareto fronts is constructed. The respectful curious reader may refer to [29] to obtain more detailed information about the non-dominated sorting algorithm.

The aim of the crowding distance criterion is to prevent packing the members of the population in a limited location of the feasible search space and remaining the rest of the search space unused. As a matter of fact, the mentioned issue help to preserve the diversity of the population. In order to achieve this goal, a quantity named crowding distance is assigned to each member of each Pareto front. This criterion shows the distance of each member of a front in relation to the neighboring members around it. After assigning this criterion, algorithm selects the members with the higher values of the crowding distance for creating new population. In fact, the individuals selected which belong to the underpopulated part of each front to help preserving the diversity of the population. The respectful curious reader may refer to [29] to obtain more detailed information about the crowding distance criterion.

As mentioned earlier, DE is a good and fast algorithm, but it has some deficiencies. Global exploration ability of DE seems proper which it can discover the possible area of the global optimum, but its local exploitation ability may be slow at fine-tuning the optimal point [30]. In addition, DE may suffer from lack of diversity which leads to the premature convergence. Sometimes, even new individuals may move to the next generation, but the algorithm cannot be successful to find any better solutions. This situation is called population stagnation [31]. Further, DE's performance highly depends on its control parameters (such as mutation factor and crossover probability) so it can be difficult to use the aforementioned parameters for various cases [32].

Due to the drawbacks of DE described above, fuzzy logic method, as mentioned in last section, is used to dynamically adjust the mutation factor, F , by considering two important factors to improve the performance of that as follows:

Number of generation

Population diversity

Since in low number of generations, it is needed to find the vicinity of global optimum (optima) so rather large movement in search space may be useful. To fulfill this matter, high number of mutation factor can be applied to explore through feasible region. But, when algorithm approaches towards global optimum (optima), it is important to fine-tuning the optimal points. Actually, it means that low number of mutation factor may be

useful to exploit through the feasible search space. For the case of population diversity, such kind of analysis can be used here. It seems that when the members of population are dense together (low density of population), low value of mutation factor for exploiting of the optimal points can be effective. On the other hand, if the individuals of population are far from together (high value of density), high value of mutation factor may be useful to explore through the feasible region [26].

Therefore, in this paper a fuzzy inference system based on two inputs namely, number of generation and population diversity and one output as mutation factor of type of Mamdani [26] is used to alter the performance of the differential evolution. Fuzzy rules used here [26] are shown in table 1.

Table 1. Fuzzy rule-based system used here [26]

| Output of fuzzy system is Mutation Factor | | Diversity | | | |
|---|--------|----------------|--------------|-----------------|--|
| | | Low | Medium | High | |
| | Low | (...) Medium | (...) High | (...) Very High | |
| Number of | Medium | (...) Low | (...) Medium | (...) High | |
| Generation | High | (...) Very Low | (...) Low | (...) Medium | |

(...): Mutation Factor must be

The respectful curious reader may refer to [26] to find more detailed information about the fuzzified mutation factor.

Therefore, fuzzified mutation factor is used in equation 6 instead of usual one and the remaining of the procedure is the same as whatever described before. As a result, whole mentioned procedure can be named multi-objective fuzzified mutation differential evolution used for Pareto optimal design of vehicle vibration model. Aforesaid procedure can be seen in figure 1.

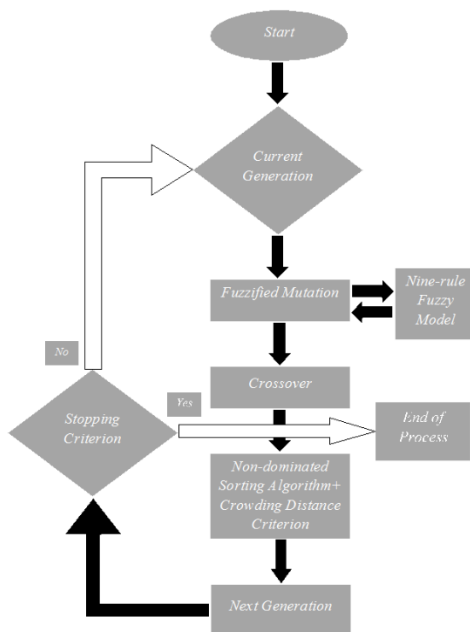

Figure 1. Schematically description of proposed algorithm.

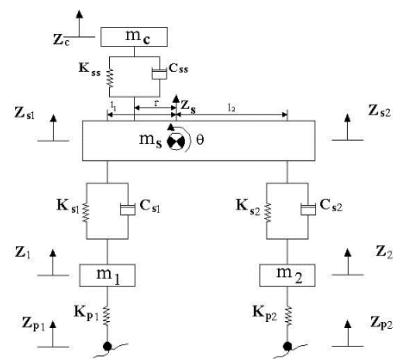

Figure 2. Vehicle vibration model [10, 12].

3 Five degree of freedom vehicle vibration model

Vehicle vibration model used here is shown in figure 2 [10, 12]. Details of fixed parameters of vehicle model and design variables used here are shown in table 2 [10, 12].

Equation of motions of vehicle model considering small angle θ can be shown as follows [10, 12]:

$$z_{ps} = z_s - r\theta \tag{8}$$

$$z_{s1} = z_s - l_1\theta \tag{9}$$

$$z_{s2} = z_s + l_2\theta \tag{10}$$

$$F_{ss} = k_{ss}(z_c - z_{ps}) + c_{ss}(\dot{z}_c - \dot{z}_{ps}) \tag{11}$$

$$F_{s1} = k_{s1}(z_{s1} - z_1) + c_{s1}(\dot{z}_{s1} - \dot{z}_1) \tag{12}$$

$$F_{s2} = k_{s2}(z_{s2} - z_2) + c_{s1}(\dot{z}_{s2} - \dot{z}_2) \tag{13}$$

$$m_c \ddot{z}_c = -F_{ss} \tag{14}$$

$$m_s \ddot{z}_s = -F_{s1} - F_{s2} + F_{ss} \tag{15}$$

$$I_s \ddot{\theta} = l_1 F_{s1} - l_2 F_{s2} - r F_{ss} \tag{16}$$

$$m_1 \ddot{z}_1 = F_{s1} - k_{p1}(z_1 - z_{p1}) \tag{17}$$

$$m_1 \ddot{z}_1 = F_{s1} - k_{p1}(z_1 - z_{p1}) \tag{18}$$

$$m_2 \ddot{z}_2 = F_{s2} - k_{p2}(z_2 - z_{p2}) \tag{19}$$

Where z_c , z_s , $z_i (i = 1,2)$, $z_{si} (i = 1,2)$ and θ indicate vertical seat displacement, vertical displacement of the center of gravity of the sprung mass, vertical displacement of the ends of the sprung mass and rotating motion (pitching motion) of sprung mass, respectively. It is important to notice that indices 1 and 2 show the axes of forward and rear tires, respectively.

This model is excited by random non-stationary road surface which obeys the following stochastic differential equation (SDE) [11] exerted to forward and rear tires:

$$\dot{z}_{pi}(t) + \dot{s}2\pi n_c z_{pi} = 2\pi n_0 \sqrt{s_q(n_0)} \dot{W}(t) \quad i = 1, 2 \tag{20}$$

In which, $n_c = 0.01 \text{ m}^{-1}$, $n_0 = 0.1 \text{ m}^{-1}$, $s_q(n_0) = 256 \times 10^{-6} \text{ m}^3$ and $W(t)$ are depicted road spatial cut-off frequency, standard spatial

Table 2. Information related to fixed parameters and design variables [10, 12]

| Parameter | Type of parameter | Dimension | Value | Upper bound | Lower bound |
|--|-------------------|-------------------|--------|-------------|-------------|
| Forward tire mass (m_1) | Fixed parameter | kg | 40 | | |
| Rear tire mass (m_2) | Fixed parameter | kg | 40 | | |
| Seat mass (m_c) | Fixed parameter | kg | 75 | | |
| Sprung mass (m_s) | Fixed parameter | kg | 730 | | |
| Momentum inertia of sprung mass (I_s) | Fixed parameter | kg.m ² | 1230 | | |
| Forward tire stiffness coefficient (k_{p1}) | Fixed parameter | kg | 175500 | | |
| Rear tire stiffness coefficient (k_{p2}) | Fixed parameter | kg | 175500 | | |
| Forward suspension position in relation to the center of mass (l_1) | Fixed parameter | m | 1.011 | | |
| Rear suspension position in relation to the center of mass (l_2) | Fixed parameter | m | 1.803 | | |
| Seat stiffness coefficient (K_{ss}) | Design variable | $\frac{N}{m}$ | | 5000 | 15000 |

| | | | | | |
|--|-----------------|-----------------------------|-------|-------|-------|
| Forward stiffness coefficient for vehicle suspension (C_{ss}) | Design variable | $\frac{N}{m}$ | | 10000 | 20000 |
| Rear stiffness coefficient for vehicle suspension (K_{s1}) | Design variable | $\frac{N}{m}$ | | 10000 | 20000 |
| Seat damping coefficient (C_{s1}) | Design variable | $\left(\frac{Ns}{m}\right)$ | | 1000 | 4000 |
| Forward damping coefficient for vehicle suspension (K_{s2}) | Design variable | $\left(\frac{Ns}{m}\right)$ | | 500 | 2000 |
| Rear damping coefficient for vehicle suspension (C_{s2}) | Design variable | $\frac{Ns}{m}$ | | 500 | 2000 |
| Seat position in relation to the center of mass (r) | Design variable | m | | 0 | 0.5 |

frequency, coefficient of road roughness for C-level road condition and stationary white noise, respectively [11]. In addition, \dot{s} indicates the vehicle velocity in horizontal direction shown by next equation:

$$\dot{s} = v_0 + at \quad (21)$$

in the above equation $v_0 = 0$ and $a = 3.6 \frac{m}{s^2}$ are initial vehicle velocity and acceleration in horizontal direction.

It is supposed that the rear tire traverses the same way as the front tire with a time delay shown by Δt ; this time delay can be achieved by solving differential equation 21 by considering the distance between forward and rear tire ($l_1 + l_2$).

Analyzing equation 20 can show the fact that if the vehicle moves with a constant velocity (zero acceleration movement), type of road input is random stationary. But, if the vehicle's velocity is not constant (non-zero acceleration movement), type of road input is non-stationary random [11].

4 Multi-objective Pareto optimization of vehicle model using multi-objective differential evolution with fuzzified mutation

In this section, the Pareto optimization of the vehicle model is done using the procedure proposed here in the 2- and 5-objective areas using the information presented in table 2. The conflicting objective functions used here are, namely, vertical seat acceleration ($\ddot{z}_c \left(\frac{m}{s^2}\right)$), vertical velocity of forward tire ($\dot{z}_1 \left(\frac{m}{s}\right)$), vertical velocity of rear tire ($\dot{z}_2 \left(\frac{m}{s}\right)$), relative displacement between sprung mass and forward tire (d_1) and relative displacement between sprung

mass and rear tire (d_2) to be minimized by finding the proper design variables through the optimization processes [10, 12].

It should be noted that in single-objective optimization one point presented as the optimum solution as the view of all the objective functions (which combined together using weighting factor to constitute a single objective). But in the multi-objective optimization, the process is done considering all the (usual) conflicting objectives simultaneously. Therefore, the results are in the form of a set of non-dominated solutions which the designer can use each of them based on the necessity.

Remainder of this section is divided into two subsections which are 2- and 5-objective optimization, respectively.

4.1 Two-objective (bi-objective) optimization of the vehicle vibration model

Four different pairs out of ten possible pairs of objectives are considered in four bi-objective optimization processes. The aforesaid pairs of objective functions used to be minimized separately, have been chosen as (\ddot{z}_c, \dot{z}_1), (\ddot{z}_c, \dot{z}_2), (\ddot{z}_c, d_1) and (\ddot{z}_c, d_2) [10, 12]. The optimization processes have been done in 240 generations using a population with 80 members, a crossover probability of 0.9 and the fuzzified adaptable mutation factor discussed earlier [26].

Pareto fronts of four above-mentioned pairs of objectives have been depicted in figures 3-

6, respectively. It can be easily seen that by selecting an optimum point in each Pareto front in order to achieve a better value for an assumed objective function lead to attain a worse value for other one and vice versa. As a matter of fact, there is a special set of design variables which cause the best values of the associated objective function shown as the Pareto front. Any other sets of objective which cannot cause the proper values of each objective function locate at the space inferior to the Pareto front [10]. The aforesaid spaces in figures 3-6 are at top/right side of each Pareto front.

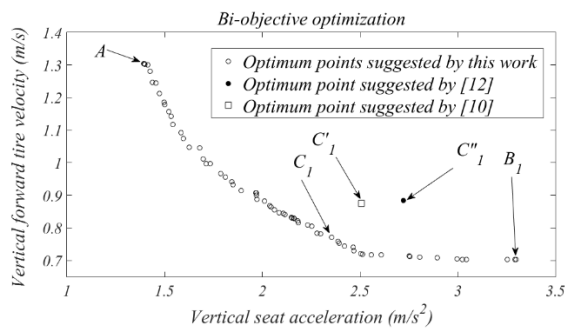

Figure 3. Pareto front of vertical seat acceleration and vertical forward tire velocity resulted by bi-objective optimization.

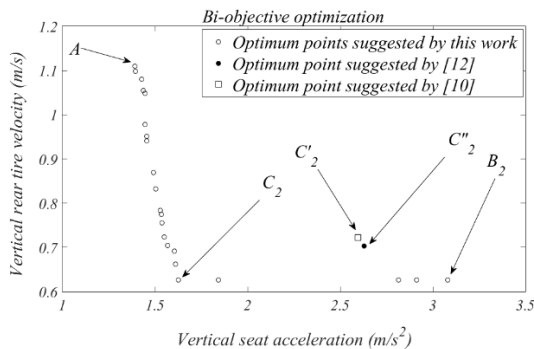

Figure 4. Pareto front of vertical seat acceleration and vertical rear tire velocity resulted by bi-objective optimization.

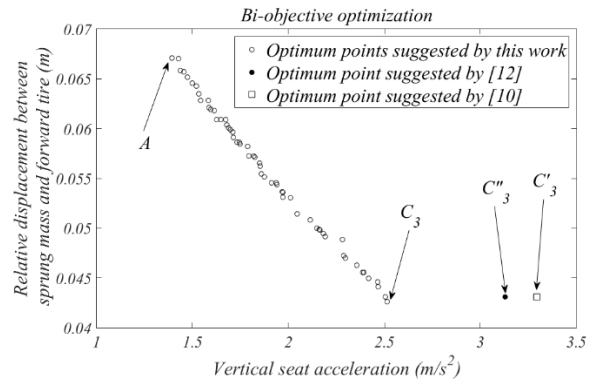

Figure 5. Pareto front of vertical seat acceleration and relative displacement between sprung mass and forward tire resulted by bi-objective optimization.

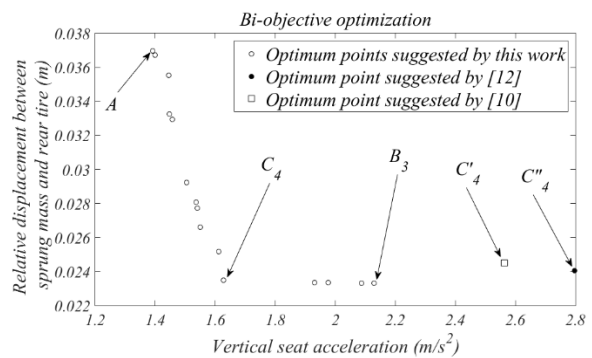

Figure 5. Pareto front of vertical seat acceleration and relative displacement between sprung mass and rear tire resulted by bi-objective optimization.

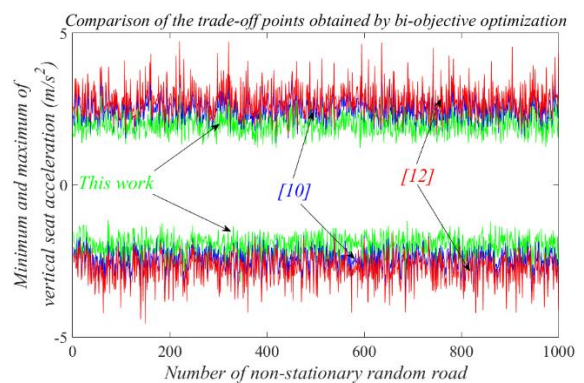

Figure 6. Minimum and maximum points of vertical seat acceleration resulted by C_1 [this work], C'_1 [10] and C''_1 [12] for the 5-degree of freedom vehicle model excited by 1000 different non-stationary random roads.

Figure 3 exhibits the Pareto front of vertical seat acceleration and vertical forward tire velocity in the bi-objective plane. In this figure, points A and B_1 show the best point of vertical seat acceleration and the best one of

vertical forward tire velocity, respectively. As shown in this figure, points C'_1 (C_1 in [10]) and C''_1 (C_1 in [12]) locate on the top/right side of the Pareto front. This important point proves the very good performance of the proposed method of this work. In figure 3, point C_1 can be a proper optimum point as the view of both objectives. As readily seen in the figure, point C_1 exhibits a negligible increase in the value of vertical forward tire velocity in comparison with that of point B_1 (the design with the least forward tire velocity) whilst its value of vertical seat acceleration improves considerably. Actually, trade-off design point C_1 could not have been found without the use of the Pareto optimum approach presented in this paper.

The Pareto frontiers of the three other pairs are shown in figures 4-6. As it can be obviously seen in the aforesaid figures, optimum points B_2 , C_3 and B_3 represent the best design point from the view of vertical rear tire velocity, relative displacement between sprung mass and forward tire and relative displacement between sprung mass and rear tire, respectively. In these figures, points C_2 , C_3 and C_4 indicate the trade-off design points. In the aforementioned figures, points C'_2 , C'_4 (C_2 , C_4 in [10]) and C''_2 , C''_4 (C_2 , C_4 in [12]) are on the top/right side of the Pareto fronts.

In figure 5, it seems that point C'_3 (C_3 in [10]) and C''_3 (C_3 in [12]) are in the right side of the Pareto front and not in the top/right side of that. But, optimum point C_3 in this figure can be a proper choice for being trade-off because it dominates both proposed point from the view of the both conflicting objective functions. Furthermore, it can be easily seen through the figures 3-4 and 6 that the other proposed trade-off points of this paper dominate the other proposed points by [10] and [12]. The values of objective functions and their associated design variables of points B_1 , B_2 , B_3 , C_1 , C_2 , C_3 , C_4 , C'_1 , C'_2 , C'_3 , C'_4 , C''_1 , C''_2 , C''_3 and C''_4 are shown in table 3.

In order to analyze the ability of the proposed optimum points obtained by multi-objective differential evolution with fuzzified mutation, vehicles designed by points C_1 (this work), C'_1 [10] and C''_1 [12] excited by 1000 non-stationary random roads are observed here

(figure 7). Comparison of the results of minima and maxima of vertical seat acceleration of each input road confirms the very good performance of the proposed point of this work. In fact, it can be readily seen in figure 7 that the values related to the minima and maxima obtained by point C_1 are lowest among the corresponding ones obtained by the proposed points of [10] and [12].

The above-mentioned important facts could not have been obtained without the use of optimum Pareto method of this work. The aforesaid information obtained by four separate bi-objective optimizations can be attained by one five objective optimization simultaneously described in the next subsection.

4.2 Five-objective optimization of the vehicle vibration model

In this subsection a five-objective optimization instead of four bi-objective optimization separately, is done using the proposed method of this work. The aforesaid five objective functions are considered to be minimized simultaneously. It is important to notice that such five-objective optimization can include the results of four bi-objective optimization previously found. The optimization process has been done in 240 generations using a population with 80 members, a crossover probability of 0.9 and the fuzzified adaptable mutation factor discussed earlier [26].

Results of the five-objective optimization are shown in figures 8-11. It seems that there are some points in each plane which dominate each other. But, when whole points resulted by the five-objective optimization considered together, they are non-dominated to each other. It can be readily seen that the results of five-objective optimization contain the ones of the corresponding bi-objective optimization. As a matter of fact, the Pareto fronts found in previous subsection constitute the border of each planes obtained by the five-objective optimization which no solutions locate in a position superior to the aforesaid border.

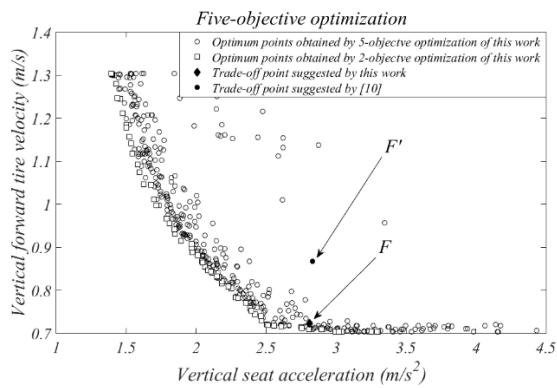

Figure 7. Vertical seat acceleration with vertical forward tire velocity in both 2- and 5- objective optimizations.

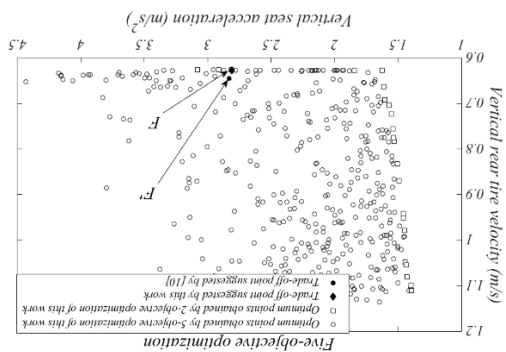

Figure 8. Vertical seat acceleration with vertical rear tire velocity in both 2- and 5- objective optimizations.

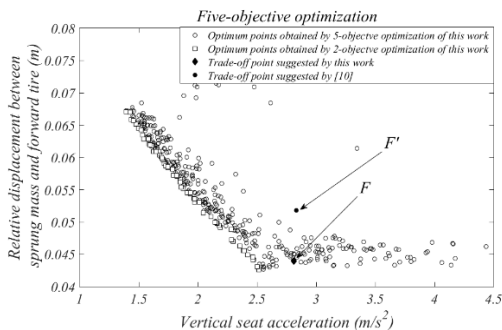

Figure 9. Vertical seat acceleration with relative displacement between sprung mass and forward tire in both 2- and 5- objective optimizations.

each point with the lowest aforesaid summation value is the trade-off optimum points which is named F here. As can be readily seen, in figures 8-11, trade-off point F is rather near to the borders of each planes and dominates trade-off point F' (point F in [10]). The values of objective functions and their associated design variables of points F and F' are presented in table 3.

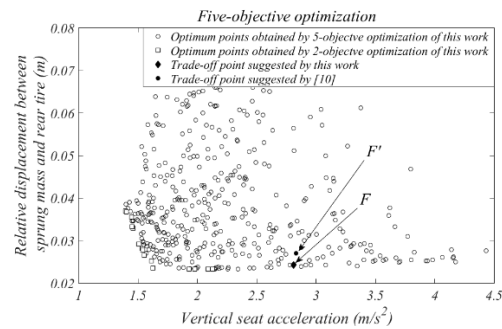

Figure 10. Vertical seat acceleration with relative displacement between sprung mass and rear tire in both 2- and 5- objective optimizations.

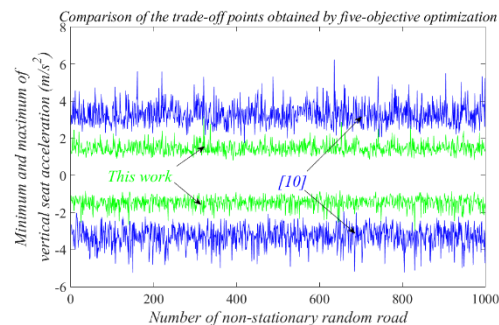

Figure 11. Minimum and maximum points of vertical seat acceleration resulted by F_1 [this work] and F' [10] for the 5-degree of freedom vehicle model excited by 1000 different non-stationary random roads.

It is time to find a solution which can compromise among all the five objectives simultaneously. As a matter of fact, the optimum points obtained by the separate four bi-objective processes are non-dominated to each other. But there is no reason that they can be in the other Pareto frontiers. Therefore, the necessity to find the above-mentioned solution is felt. In this way, the values of five objective functions of all the optimum non-dominated points are transformed into interval zero and one. Then the transformed valued are summed each other for each of the optimum points. It can be easily figured out that

As done in the previous subsection, vehicles designed by points F (this work) and F' [10] excited by 1000 non-stationary random roads are observed here to examine the ability of the proposed method of this work (figure 12). Comparison of the results of minima and maxima of vertical seat acceleration of each input road confirms the very good performance of the proposed point of this work. Actually, it can be readily found in figure 12 that the values related to the minima and maxima obtained by point F

are lower than the corresponding ones obtained by the proposed point of [10].

Table 1. Values of objective functions and their associated design variables of the optimum points proposed by this work and the ones of [10, 12]

| | k_{ss} | C_{ss} | K_{s_1} | C_{s_1} | K_{s_2} | C_{s_2} | r | \dot{z}_c | d_1 | d_2 | \dot{z}_1 | \dot{z}_2 |
|---------|----------|----------|-----------|-----------|-----------|-----------|----------|-------------|-----------|-----------|-------------|-------------|
| A | 50195.9 | 1832.90 | 10003.54 | 500.110 | 18866 | 501.628 | 0.472488 | 1.39203 | 0.067085 | 0.036970 | 1.30356 | 1.11013 |
| B_1 | 50385.67 | 1895.76 | 19981.0 | 1999.9 | 10693.1 | 1940.76 | 0.387792 | 3.29802 | 0.0460817 | 0.028797 | 0.703351 | 0.649977 |
| B_2 | 51120.4 | 1290.58 | 10003.4 | 1936.28 | 19998.5 | 1999.91 | 0.498184 | 3.08173 | 0.044261 | 0.024257 | 0.728469 | 0.626211 |
| B_3 | 50365.5 | 1919.41 | 13306.9 | 500.261 | 19998.5 | 1999.91 | 0.399703 | 2.12941 | 0.076021 | 0.023296 | 1.28811 | 0.626469 |
| C_1 | 50589.2 | 1797.02 | 10001.1 | 1703.04 | 10072.6 | 589.935 | 0.439419 | 2.35564 | 0.046300 | 0.060718 | 0.770300 | 1.06836 |
| C_2 | 50467.7 | 1778.49 | 10012.3 | 500.222 | 19998.5 | 1999.91 | 0.489250 | 1.62659 | 0.065951 | 0.023499 | 1.30349 | 0.626406 |
| C_3 | 50276.7 | 2483.95 | 10000.1 | 2000 | 10000.1 | 509.213 | 0.000043 | 2.51411 | 0.042630 | 0.068094 | 0.718504 | 1.12987 |
| C_4 | 50467.7 | 1778.49 | 10012.3 | 500.222 | 19998.5 | 1999.91 | 0.489250 | 1.62659 | 0.065951 | 0.023499 | 1.30349 | 0.626406 |
| C'_1 | 111177 | 3858.82 | 10000 | 1264.71 | 10117.7 | 1852.94 | 0.49804 | 2.50693 | 0.052170 | 0.028169 | 0.875027 | 0.663335 |
| C'_2 | 131961 | 3400 | 10000 | 1282.35 | 10000 | 1511.77 | 0.46863 | 2.59635 | 0.051910 | 0.032129 | 0.870031 | 0.722343 |
| C'_3 | 134706 | 2505.88 | 10000 | 2000 | 10078.4 | 1511.77 | 0.5 | 3.29476 | 0.043117 | 0.032805 | 0.718302 | 0.722187 |
| C'_4 | 98235.3 | 2917.65 | 10000 | 1311.77 | 18313.7 | 1994.12 | 0.5 | 2.56306 | 0.052073 | 0.024513 | 0.861698 | 0.629932 |
| C''_1 | 144263.6 | 3119.213 | 10003.33 | 1232.827 | 10029.59 | 1989.187 | 0.496346 | 2.72220 | 0.052652 | 0.026948 | 0.884721 | 0.644679 |
| C''_2 | 139269.5 | 3484.991 | 10000.42 | 1259.879 | 10036.32 | 1613.628 | 0.471118 | 2.62818 | 0.052249 | 0.0307688 | 0.876576 | 0.702759 |
| C''_3 | 147210.7 | 3768.222 | 10001.55 | 1999.947 | 10003.77 | 1432.873 | 0.492994 | 3.12842 | 0.043108 | 0.034027 | 0.718101 | 0.738786 |
| C''_4 | 146265.7 | 3482.942 | 10000.25 | 1336.778 | 19999.92 | 1999.609 | 0.499107 | 2.79624 | 0.051785 | 0.024040 | 0.854808 | 0.6263638 |
| F | 50976.6 | 2396.39 | 10006.5 | 1968.389 | 19998.6 | 1997.248 | 0.459830 | 2.809716 | 0.043934 | 0.02432 | 0.723237 | 0.626598 |
| F' | 144902 | 2788.24 | 10000 | 1294.12 | 10196.1 | 1982.35 | 0.49608 | 2.832621 | 0.051777 | 0.027044 | 0.866753 | 0.645288 |

To show the ability of the proposed approach of this paper thoroughly, vehicles designed by points F (this work) and F' [10] are also excited by double-bump (figure 13) [10] as shown in figure 14. As seen through this paper, the optimum points suggested here such as trade-off point F are design based on the random non-stationary road input. But, point F' [10] has been specifically designed for the vehicle excited by a double bump [10]. Therefore, such test can prove the ascendancy of the results of this paper more transparently. As observed in figure 14, the time behavior of vertical seat acceleration of the aforesaid points are close together. As a result, it seems possible to use the trade-off optimum

point F (this work) instead of F' [10] to optimally design such a vehicle crossing double-bump [10]. The above-mentioned points shows the superiority of the method and results of this paper. It is obvious through this work that the significant presented results would not have been obtained without the multi-objective method of this paper.

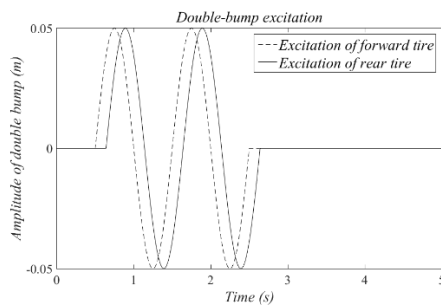

Figure 12. Double-bump excitation [10, 12].

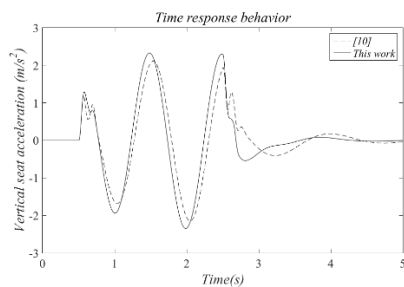

Figure 13. Comparison of time response behavior of vertical seat acceleration obtained by point F (this work) and F' [12].

5 Conclusion

A new multi-objective approach based on the combination of differential evolution using fuzzified mutation with non-dominated sorting algorithm and crowding distance criterion was used to optimally design the vehicle vibration model excited by non-stationary random road surface. To achieve a dynamically adjustable mutation factor, the number of generation along with population diversity were adopted as inputs and the mutation factor as output to constitute the nine-rule fuzzy model. The objective functions which conflict with each other were opted as vertical seat acceleration, vertical forward tire velocity, vertical rear tire velocity, relative displacement between sprung mass and forward tire and relative displacement between sprung mass and rear tire. The optimization processes have been done in both 2- and 5-objective areas and it has been depicted that the results of 5-objective optimization encompass those of bi-objective optimization in terms of Pareto frontiers. Additionally, the superiority of the obtained optimum design points was proved in comparison with those reported in the literature.

References

[1] A. Jamali, M. Salehpour, N. Nariman-zadeh, Robust Pareto active suspension design for vehicle vibration model with probabilistic uncertain parameters, *Multibody System Dynamics*, Vol. 30, No. 3, pp. 265-285, 2013.

[2] N. Yagiz, Y. Hacıoglu, Backstepping control of a vehicle with active suspensions, *Control Engineering Practice* 16 (2008) 1457–1467.

[3] M. Fleps-Dezasse, J. Brembeck, LPV Control of Full-Vehicle Vertical Dynamics using Semi-Active Dampers, *IFAC-PapersOnLine* 49-11 (2016) 432–439.

[4] Ş. Yildirim, Vibration control of suspension systems using a proposed neural network, *Journal of Sound and Vibration*, Vol. 277, No. 4-5, pp. 1059–1069, 2004.

[5] A.E. Baumal, J.J. McPhee, P.H. Calamai, Application of genetic algorithms to the design optimization of an active vehicle suspension system, *Comput. Methods Appl. Mech. Engrg.* 163 (1998) 87-94.

[6] J. Marzbanrad, G. Ahmadi, Y. Hojjat, H. Zohoor, Optimal Active Control of Vehicle Suspension System Including Time Delay and Preview for Rough Roads, *Journal of Vibration and Control* (8) 967–991, 2002.

[7] P. Chen, A. Huang, Adaptive sliding control of non-autonomous active suspension systems with time-varying loadings, *Journal of Sound and Vibration* 282 (2005) 1119–1135.

[8] H. Gao, J. Lam, C. Wang, Multi-objective control of vehicle active suspension systems via load-dependent controllers, *Journal of Sound and Vibration* 290 (2006) 654–675.

[9] H. Du, N. Zhang, H_∞ control of active vehicle suspensions with actuator time delay, *Journal of Sound and Vibration* 301 (2007) 236–252.

[10] N. Nariman-Zadeh, M.Salehpour, A.Jamali, E.Haghighoo, Pareto optimization of a five degree of freedom vehicle vibration model using a multi-objective uniform-diversity genetic algorithm (MUGA), *Engineering Applications of Artificial Intelligence*, Vol. 23, No. 54, pp. 543–551, 2010.

[11] L. Guo, L. Zhang, Robust H_∞ control of active vehicle suspension under nonstationary running, *Journal of Sound and Vibration*, Vol. 331, No. 26, pp. 5824–5837, 2012.

[12] M.J. Mahmoodabadi A. Adljooy Safaie, A. Bagheri, N. Nariman-zadeh, A novel combination of Particle Swarm Optimization and Genetic Algorithm for Pareto optimal design of a five-degree of freedom vehicle vibration model, *Applied Soft Computing*, Vol. 13, No. 5, pp. 2577–2591, 2013.

[13] G. Renner, A. Ekárt, Genetic algorithms in computer aided design, *Computer-Aided Design*, Vol. 35, No. 8, pp 709-726, 2003.

[14] S. Kitayama, M. Arakawab, K. Yamazaki, Differential evolution as the global optimization technique and its application to structural optimization, *Applied Soft Computing* 11 (2011) 3792–3803.

[15] N. Srinivas, K. Deb, Multiobjective Optimization Using Nondominated Sorting in Genetic Algorithms, *Evolutionary Computation*, Vol. 2, No. 3, pp. 221–248, 1994.

[16] A. Toffolo, E. Benini, Genetic Diversity as an Objective in Multi-Objective Evolutionary

- Algorithms, *Evolutionary Computation* Vol. 11, No. 2, pp. 151-167, 2003.
- [17] R. Storn, K. Price, Differential evolution: a simple and efficient adaptive scheme for global optimization over continuous spaces. Technical report TR-95-012. Berkeley (USA): International Computer Science Institute; 1995.
- [18] R. Storn, K. Price, Differential evolution-a simple and efficient heuristic for global optimization over continuous spaces, *Journal of Global Optimization*, 11(4) (1997) 341–59.
- [19] L. Coelho, T. Bora, V. Mariani, Differential evolution based on truncated Lévy-type flights and population diversity measure to solve economic load dispatch problems, *Electrical Power and Energy Systems* 57 (2014) 178–188.
- [20] J. Vesterstrom, R. Thomsen, A Comparative Study of Differential Evolution, Particle Swarm Optimization, and Evolutionary Algorithms on Numerical Benchmark Problems, *Congress on Evolutionary Computation* 2 (2004) 1980 -1987.
- [21] D. Zaharie, Influence of crossover on the behavior of Differential Evolution Algorithms, *Applied Soft Computing*, Vol. 9, No. 3, pp. 1126–1138, 2009.
- [22] M. Asafuddoula, T. Ray, R. Sarker, An adaptive hybrid differential evolution algorithm for single objective optimization, *Applied Mathematics and Computation* 231 (2014) 601–618.
- [23] Y. Wang, H. Li, T. Huang, L. Li, Differential evolution based on covariance matrix learning and bimodal distribution parameter setting, *Applied Soft Computing* 18 (2014) 232–247.
- [24] L. A. Zadeh, *Fuzzy Sets, Information and Control* 8 (1965) 338-353.
- [25] P. Ochoa, O. Castillo, J. Soria, Differential Evolution with Dynamic Adaptation of Parameters for the Optimization of Fuzzy Controllers, O. Castillo, P. Melin (Eds.), *Fuzzy Logic Augmentation of Nature-Inspired Optimization Metaheuristics, Studies in Computational Intelligence, Theory and Applications*, Vol. 574, pp. 49-63, Springer International Publishing Switzerland, 2015.
- [26] M. Salehpour, A. Jamali, A. Bagheri, N. Nariman-zadeh, A new adaptive differential evolution optimization algorithm based on fuzzy inference system, *Engineering Science and Technology, an International Journal*, Vol. 20, No. 2, pp. 587–597, 2017.
- [27] J. S. Arora, *Introduction to Optimum Design* (Second Ed.), 2004, Elsevier Inc., ISBN: 0-12-064155-0.
- [28] I. Gholaminezhad, A. Jamali, A multi-objective differential evolution approach based on ϵ -elimination uniform-diversity for mechanism design, *Structural and Multidisciplinary Optimization*, Vol. 52, No. 5, pp. 861–877, 2015.
- [29] K. Deb, A. Pratap, S. Agarwal, A fast and elitist multiobjective genetic algorithm: NSGA-II, *IEEE Transactions on Evolutionary Computation*, Vol. 6, No. 2, pp. 182-197, 2002.
- [30] N. Noman, H. Iba, Accelerating Differential Evolution Using an Adaptive Local Search, *IEEE Transactions on Evolutionary Computation* 12 (2008) 107-125.
- [31] Jouni Lampinen, Ivan Zelinka, On Stagnation of the Differential Evolution Algorithm, 6th international conference on soft computing MENDEL 2000, Brno, Czech Republic, June 7-9, 2000, 76-83, ISBN 80-214-1609-2.
- [32] A. W. Mohamed, RDEL: Restart Differential Evolution algorithm with Local Search Mutation for global numerical optimization, *Egyptian Informatics Journal* 15 (2014) 175–188.